



INSTALLATION GUIDE: CCX™ CHANNEL LINING



RAIL



ROAD



MINING



PETROCHEM



AGRO



PUBLIC WORKS



UTILITIES



DEFENCE



DESIGN



SHELTER

1.0 General

CCX™ is part of a revolutionary class of construction materials called Geosynthetic Cementitious Composite Mats and Barriers (GCCM/Bs). It is a flexible, concrete filled geosynthetic, that hardens on hydration to form a thin, durable, water proof concrete layer. Essentially, it can be described as Concrete on a Roll™ and is used for a wide variety of applications including the rapid lining of drainage channels, providing slope protection, weed suppression, culvert repair and general concrete remediation. Three variants of CCX™ are currently available: CCX-UTILITY™ (CCX-U™), CCX-MAT™ (CCX-M™) & CCX-BARRIER™ (CCX-B™). Although each variant has different intended uses, all are classed as Type II GCCMs to specification standard ASTM D8364.

The information contained in this document is provided subject to the General Disclaimer on the last page of this document. A printable copy of the current version of our General Disclaimer is maintained at the following link [here](#). Subject to the above, this document provides general guidance procedures for the installation of CCX™ for channel lining. However:

- This installation guidance should be read in conjunction with the construction drawings taking account of the designer's project specifications. Consult the [CC Specification Guide: Watercourses](#) for standardised design and installation advice.
- The versatile nature of CCX™ means that this document is not exhaustive and is intended for guidance purposes only. Exceptions to this guideline may be required to address site-specific conditions.
- The performance of the CCX™ is wholly dependent on the quality of its design and installation. It is the installer's responsibility to adhere to these guidelines where applicable and to the project specification and construction drawings.

2.0 Equipment Required

- Sufficient CCX-M™ or CCX-B™ (as specified by the project engineer) to complete the project including allowance for edge fixings and overlaps
- Suitable lifting equipment to dispense the CCX™ Rolls
- Safety mask and gloves
- Mole grips or flat welding clamps
- Cutting equipment, snap off knife or disc cutter
- Metal or plastic fixing pins
- Lump hammer
- Fixings for jointing (to the project engineers' specification) and appropriate fixing equipment, consult the [CCX™ Jointing Guide](#)
- Water supply
- See the [CC Equipment List](#) for full details.
- For ordering, offloading and storage information, contact Concrete Canvas Ltd
- Dust hazard. Wear appropriate PPE. Consult the [CCX™ SDS](#) document.

3.0 Substrate Preparation

Divert water (if lining an existing watercourse). Remove vegetation and grade channel to a uniform profile to suit the design dimensions.

Remove sharp or protruding rocks >25mm and fill large voids. If the perimeter edge of the CCX™ is terminating in a soil substrate (i.e. it is not going to be connected to existing infrastructure), excavate crest anchor trenches into the shoulders of the channel. Excavate Leading and Trailing edge anchor trenches on side slopes and along the invert. Anchor trench dimensions must be a minimum of

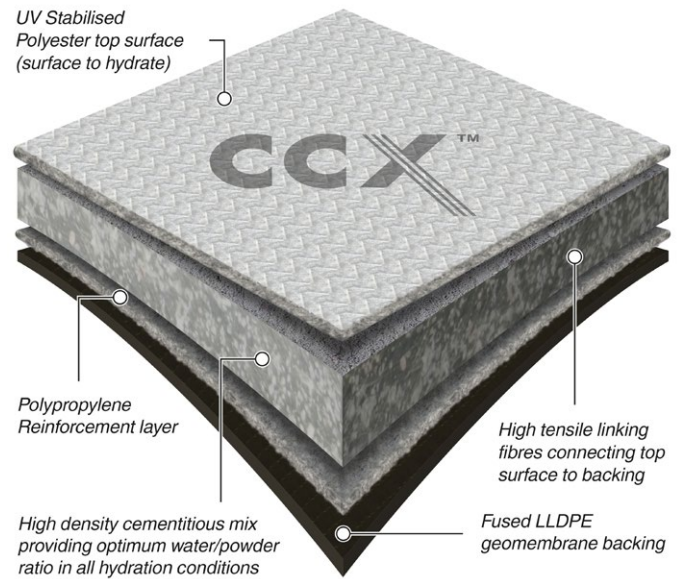

Typical CCX™ cross section

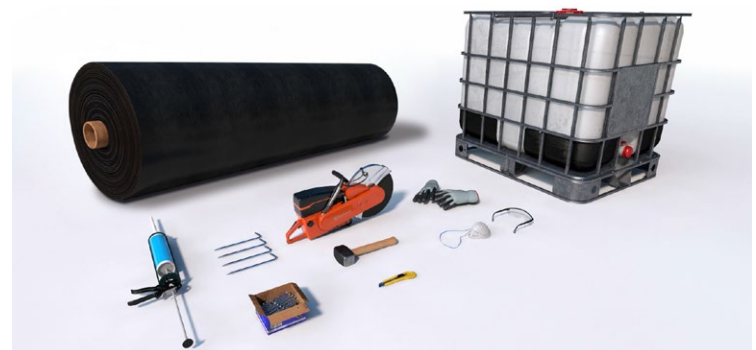

Equipment required

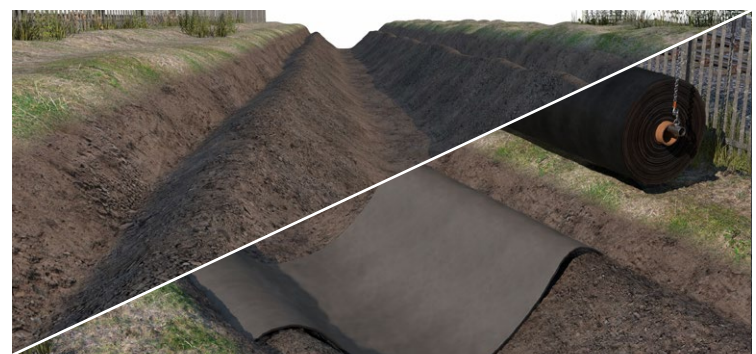

Substrate preparation & anchor trench

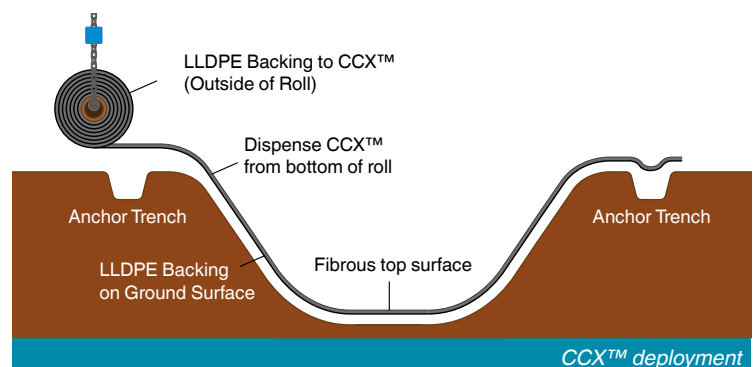

150mm x 150mm but may need to be increased to suit the designer's requirements.

Consult the construction drawings to verify if special substrate preparation measures such as minimum bearing capacity requirements, installation of a non-woven geotextile, or if substrate drainage details are needed. CCX-B™ must always be installed on a geotextile or suitably prepared surface to prevent damage to the LLDPE backing.

4.0 Deployment

CCX™ must be placed to ensure direct contact with the surface to prevent void space. Begin at downstream end of the channel and work up gradient.

Remove packaging (making sure to note the Roll ID) and unroll CCX™ in the channel profile to suit specified layup (longitudinal or transverse layup as specified on the design drawings), ensuring the fibrous top surface faces upwards, with the LLDPE backing in contact with the ground. This is achieved by dispensing the roll by naturally unrolling along the ground rather than pulling material from the top. Avoid snagging the CCX™ on the substrate. It is important to relax the material to relieve any tension generated in deployment. This can be achieved by lifting the CCX™ layer by hand and repositioning. The installer can adjust the material to remove any wrinkles and ensure the CCX™ conforms to the substrate when hand repositioning.

Personnel must not wear damaging shoes and avoid walking on the CCX™ surface to prevent staining, particularly with wet footwear prior to hydration. On restricted access projects where installers have no option but to walk on CCX™, the surface can be protected by using timber boards to prevent boots from creating depressions in the material.

For transverse layup installations, tuck the edge of the CCX™ into the anchor trench before cutting to length. When cutting unset CCX™, a 15-20mm allowance should be left from the cut edge due to potential loss of fill. If cutting with a disc cutter, it is recommended to wet the cut beforehand to minimise dust generation.

Ensure the trailing edge of the first layer of CCX™ is either suitably terminated into existing infrastructure and fixed to prevent water ingress (e.g. using stainless steel clamping bar and gasket), or tucked into an anchor trench which is backfilled, with non-erodible fill, to prevent scour beneath the CCX™.

When positioning subsequent layers, ensure there is at least a 100mm overlap in the direction of water flow (shingled like roof tiles) and that the material layers are in intimate contact with each other. When measuring overlaps, the minimum overlap must be measured from the edge of the cementitious material.

Care shall be taken during installation to avoid damage occurring to the CCX™. Should the CCX™ be damaged during installation and before hydration, the layer should be removed and replaced.

If necessary, the Installer must place temporary ballast, such as sandbags, on top of the laid CCX™ prior to hydration to prevent wind uplift and ensure that it lies flat to the substrate on undulating ground to prevent voids from forming underneath the material.

5.0 Jointing

It is important that the correct CCX-M™ or CCX-B™ joint method is used to meet the project permeability requirements. Verify the specified joint method to be installed from the project engineer and

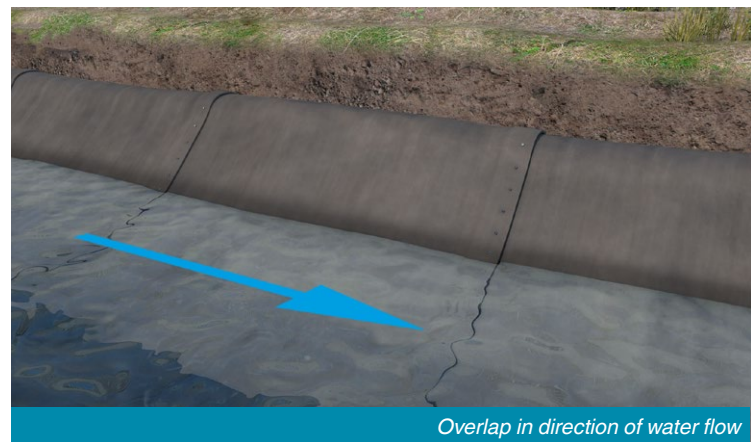

*Screw spacing & use of adhesive sealant is dependent on the design

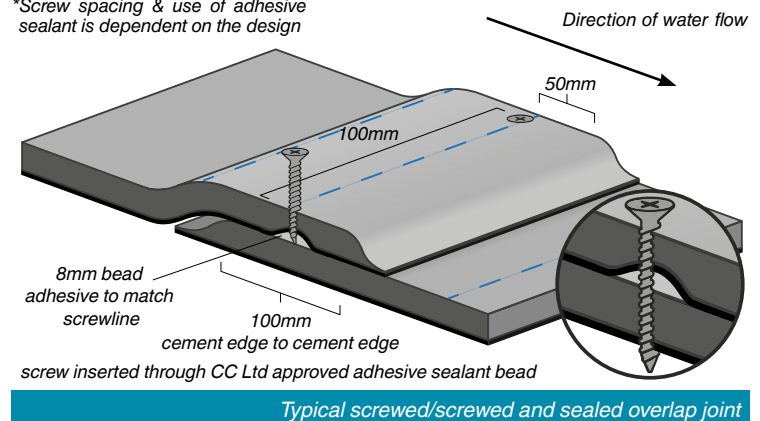

follow the detailed guidance in the *CCX™ Jointing Guide*.

Ensure there is no rucking at the joint and both layers are in contact with each other.

6.0 Perimeter Edge Fixing

It is essential that all exposed (i.e. unjointed) edges of the CCX™ should be secured during the installation to prevent water ingress underneath the CCX™ which may cause wash-out of the substrate and subsequent undermining.

6.1 When fixing to Soil (i.e. using anchor trenches):

- Position the CCX™ over the shoulder of the channel and into the anchor trench.
- Fix the CCX™ in the anchor trench by inserting fixing pegs through each overlap or at a minimum of 2m intervals for longitudinal installations.
- The CCX™ should be hydrated before backfilling with non-erodible fill. This may be soil or concrete depending on the design. Consult the construction drawings.

6.2 When fixing to Concrete/Masonry/Rock:

- Consult the construction drawings for the mechanical fixing specifications and fixing spacings.
- Position the CCX™ against the structure and drill a pilot hole through the CCX™ and the structure before inserting the mechanical fixing.
- Use appropriate sealant/gasket and washers/clamping bar as specified by the designer to ensure a strong, watertight seal.

Ensure the leading edge of the final layer of CCX™ is either suitably terminated into existing infrastructure and fixed to prevent water ingress (e.g. using stainless steel or galvanised clamping bar and gasket), or tucked into an anchor trench which is backfilled to prevent scour beneath CCX™.

7.0 Intermediate Fixings

Additional intermediate fixings may be necessary to profile CCX™ on uneven substrates to ensure it conforms to the underlying surface and remove voids, or to resist the following load conditions:

- Hydraulic Shear Loads: e.g. lining channels with an incline >10%
- Warmer Climate Detailing: e.g. where CCX™ profile lengths exceed 3m.

The intermediate fixing type, performance requirements and installation locations should be specified by the designer to suit the anticipated load conditions. 'Round Head' fixing pegs are typically used for profiling and warmer climate detailing. When a greater head plate diameter or pull-out strength is required, for example when designing to resist hydraulic shear or wind uplift, larger intermediate fixings such as Earth Percussion Anchors may be specified. Mid-channel anchor trenches (known as check slots) may also be required by the designer, or incorporated into large installations at the end of the working day to prevent scour and undermining of the CCX™ before returning to continue the installation. Consult the construction drawings.

8.0 Bespoke Detailing

Consult the construction drawings for bespoke detailing such as baffling, accommodating pipe penetrations and junctions. Concrete Canvas Ltd can provide advice on unforeseen bespoke details.

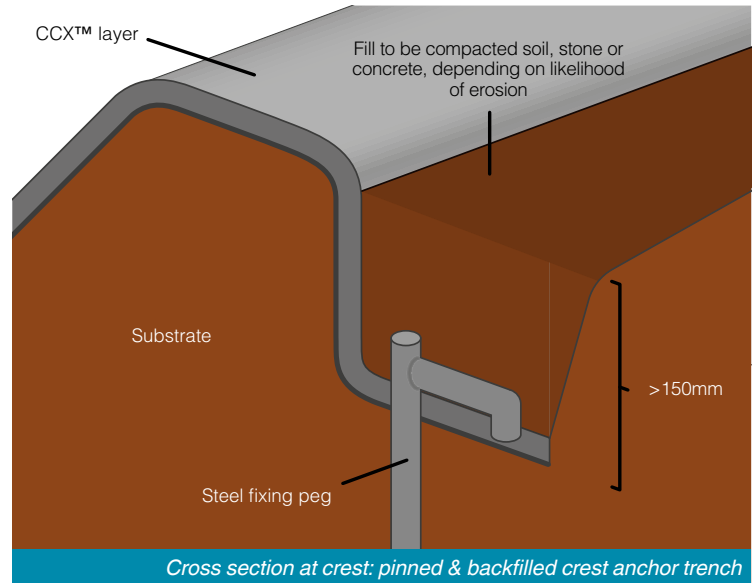

Cross section at crest: pinned & backfilled crest anchor trench

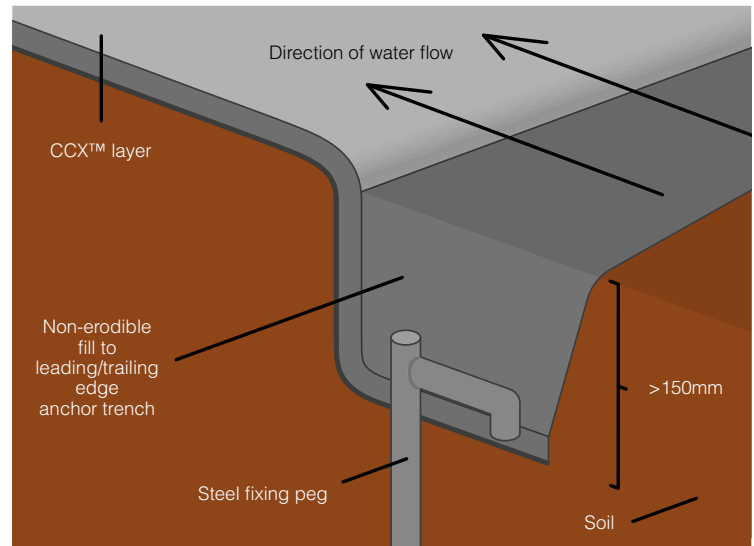

Cross section at invert edge: leading/trailing edge anchor trench detail

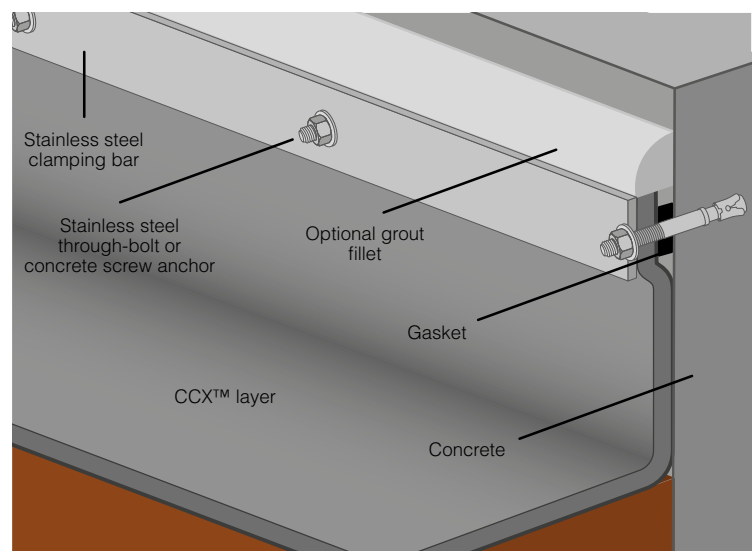

Edge fixing to concrete: clamping bar with neoprene gasket and grout fillet

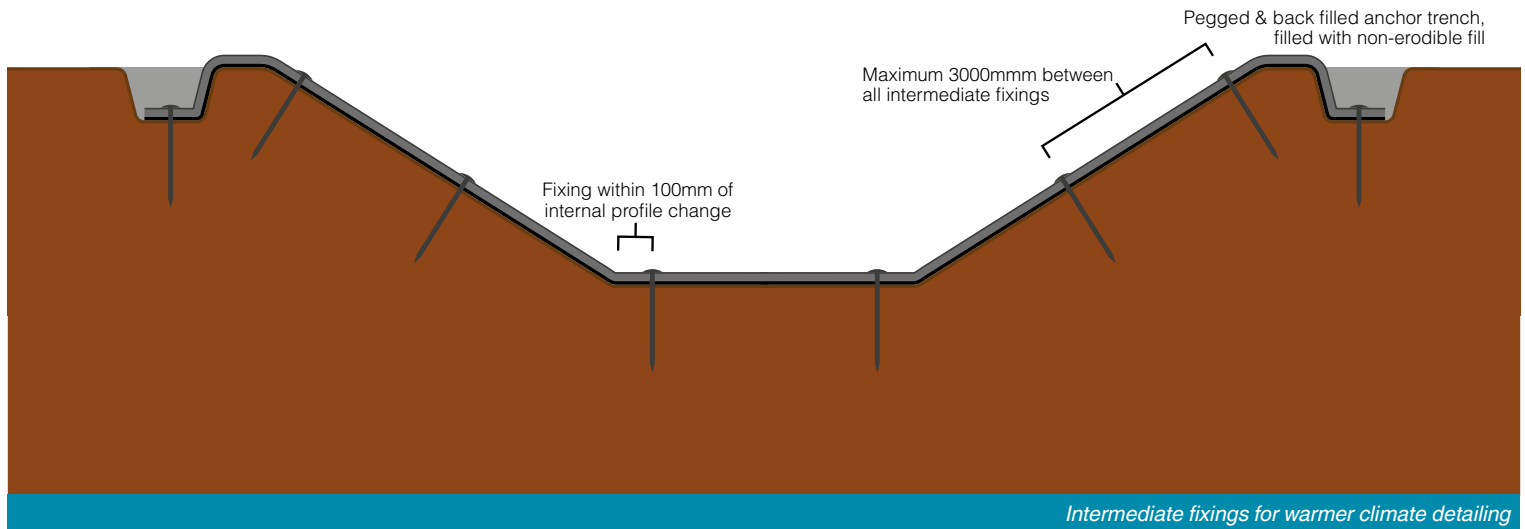

Intermediate fixings for warmer climate detailing

9.0 Hydration

After fixing and jointing, the surface of the CCX™ can be brushed clean to remove marks and debris before spraying with water to hydrate.

Spray the fibre surface multiple times until the CCX™ is fully saturated. Follow the [CCX™ User Guide: Hydration](#).

Do not spray high pressure water directly onto the CCX™ as this may wash a channel in the material.

CCX™ can be hydrated using fresh water or salt water, it is not possible to over hydrate CCX™ and it will hydrate and set underwater.

A minimum volume of water of 7.5 litres per square metre of CCX™ should be used and always respray within 30 minutes of initial hydration. An excess of water is always recommended.

To check proper hydration, the CCX™ should feel wet to the touch several minutes after hydration. Press your thumb into the CCX™ and release. If water is present in the depression in the CCX™, it has been sufficiently hydrated. If no water is observed, then more water must be applied. **RINSE HANDS IMMEDIATELY AFTER THE TOUCH TEST.**

Specific hydration methods are required in drying conditions (installing in high ambient temperatures (>22°C), wind (>12km/h), strong direct sunlight or low humidity (<70%)) and in low temperature conditions. Please consult the [CCX™ User Guide: Hydration](#) which is also attached on all CCX™ rolls.

It is not recommended to rely on rainfall to provide hydration.

10.0 Setting

There is a 30 minute working time after initial hydration. Backfill anchor trenches with non-erodible fill as specified in the construction drawings to create a neat termination and encourage surface water runoff to flow over the anchor trench and in to the CCX™ channel.

CCX™ hardens to strength in 24 hours and is then ready for use. Allow the CCX™ to cure for at least 48 hours before applying any post installation surface treatments such as jet washing or painting.

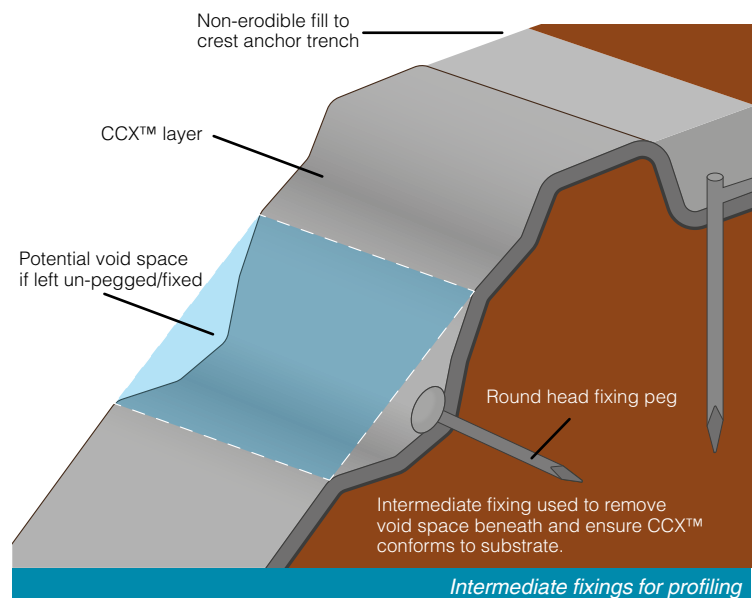

Intermediate fixings for profiling

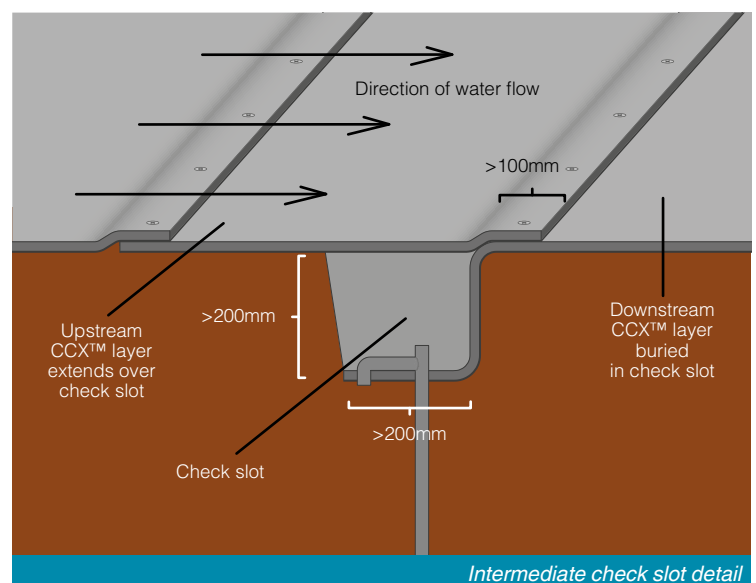

Intermediate check slot detail

11.0 Installation Sequence

Planning of CCX™ installations is necessary to ensure tools and materials (e.g. hydration water) are available when required.

Only install what can be fully jointed, fixed and hydrated before the end of construction day to minimise any adverse effect on the installation and/or performance capabilities of the product.

If installation continues the following working day, protect the edge of the last layer of CCX™ overnight with waterproof sheeting to enable jointing on return to work. Alternatively install check slots.

An example install sequence is described below:

- Morning - Deploy CCX™ panels and secure along the perimeter edges.
- Early afternoon - Jointing of panels, install intermediate fixings.
- Late afternoon - Hydration (following drying/low temperature condition guidance as required).

12.0 Inspection, Maintenance and Repair

CCX™ lined structures should be inspected 24hours after hydration and at regular intervals thereafter. Consult the [CC User Guide: Inspection, Cleaning and Maintenance](#) for more details. For the majority of projects, CCX™ does not require cleaning or maintenance.

General Disclaimer:

“The information in this document is provided for general information only as an indication as to the potential use of our products. It does not amount to advice which any person can rely on and it does not form part of any contract. To the fullest extent permitted by law, neither Concrete Canvas Ltd nor any of its officers, employees, consultants or group companies accepts any duty of care and shall not be liable for any loss, damage, cost or expense however arising from any use of, or reliance on, this information.

Subject to the above, the information may assist clients, designers and contractors (including the principal contractor and principal designer) to address their obligations under applicable law. The third party specifier, architects, engineers, designers and/or other contractors for a particular project shall bear the sole responsibility for the determination of the suitability of our products for a particular project or application and the preparation and approval of design, construction and installation plans and instructions therefore, taking into account all associated risks and health & safety implications. By providing this document, neither Concrete Canvas Ltd nor any of its officers, employees, consultants or group companies accepts any appointment to work on any project in the capacity of designer, contractor or otherwise and no legal relationship shall be created thereby.

Patent and trade mark information concerning our products can be found at www.concretcanvas.com/patent-trademark-info”



Hydration



Hydration touch test



Ensure adequate hydration, do not rely on rainfall



Backfill anchor trench