

Mirafi[®] High Strength Reinforcement Geotextiles for Piled Embankment Applications



Mirafi® High Strength Reinforcement Geotextiles for Piled Embankment Applications

CONTENTS

- 1 General
- 2 Product and Application
- 3 Material Identification, Storage and Handling
- 4 Ground Preparation
- 5 Installation
 - 5.1 *For piled embankment requiring reinforcement geotextile in one direction*
 - 5.2 *For piled embankment requiring reinforcement geotextiles in two directions*
- 6 Jointing
- 7 Typical Anchorage Options
- 8 Backfilling and Compaction

Mirafi® High Strength Reinforcement Geotextiles for Piled Embankment Applications

1. General

This document is prepared to help ensure that the high strength reinforcement geotextile, once installed, will perform its intended design functions. To do so, the product must be identified, handled, stored and installed in such a way that its physical property values are not affected and the design conditions are ultimately met as intended. This document does not account for every possible construction scenario. This document contains information consistent with generally accepted practices of identifying, handling, storing and installing high strength reinforcement geotextiles for most piled embankment applications. Failure to follow these guidelines may result in the unnecessary failure of the geotextile in an otherwise properly designed application.

2. Product and Application

Mirafi® high strength reinforcement geotextiles are manufactured from high modulus polyester multifilament yarns woven to form a high tensile modulus and robust fabric (see Figure 1). Mirafi® high strength reinforcement geotextiles are engineered to perform long-term soil reinforcement function in variety of civil and environmental applications such as piled embankment (see Figure 2). Mirafi® high strength reinforcement geotextiles provide high tensile modulus to ensure embankment stability and to control the deformation.



Figure 1. Mirafi® high strength reinforcement geotextile

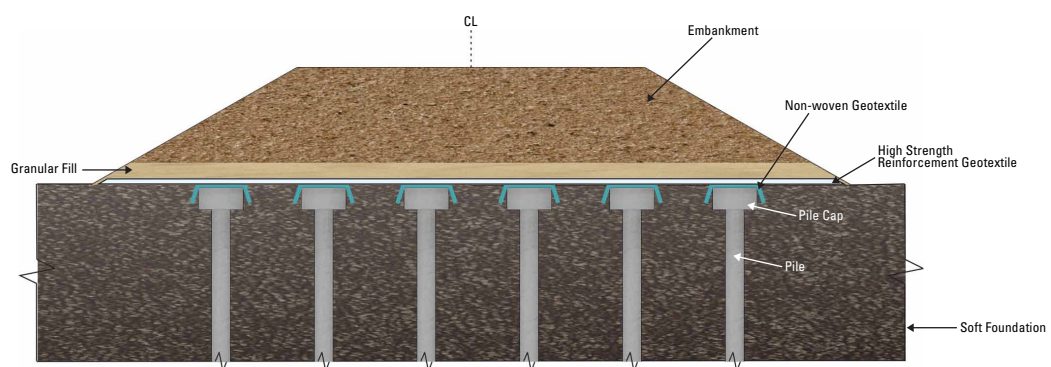

Figure 2. Typical section of Mirafi® high strength geotextile reinforced embankment on piles

3. Material Identification, Storage and Handling

The geotextile shall be rolled on cores having strength sufficient to avoid collapse or other damage from normal use. Each roll shall be wrapped with a plastic covering to protect the geotextile product from damage during shipping and handling. Each roll shall be identified with a durable gummed label or the equivalent, clearly legible on the outside of the roll wrapping. The label shall indicate the manufacturer's name, the style number and the roll number.

Mirafi® High Strength Reinforcement Geotextiles for Piled Embankment Applications

Upon delivery, check the roll labels to verify that the correct geotextile product has been received. Immediately inspect the geotextile rolls to ensure it is free of any flaws or damage that might have occurred during shipping or handling. While unloading or transferring the geotextile from one location to another, care should be taken to prevent damage to the wrapping, core, label or the geotextile itself.

If the geotextile is to be stored for an extended period of time, the geotextile shall be located and placed in a manner that ensures the integrity of the wrapping, core and label as well as the physical properties of the geotextile product. This can be accomplished by elevating the geotextile rolls off the ground on dunnage (see Figure 3).

Care should be taken to ensure that the geotextile rolls are adequately covered and protected from ultraviolet radiation, chemicals that are strong acids or strong bases, fire or flames including welding sparks, temperatures in excess of 60°C, and human or animal destruction.

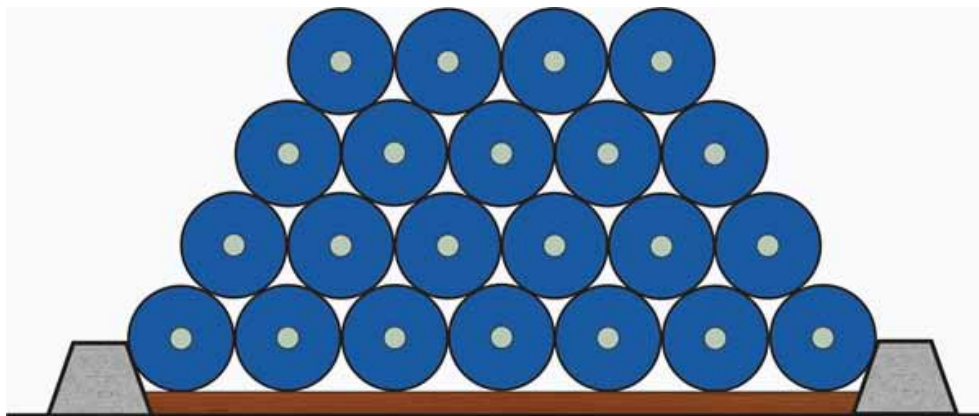

Figure 3. Recommended setup for safe onsite stacked storage of Mirafi® high strength reinforcement geotextile rolls

4. Ground Preparation

Excavate and grade the ground surface, according to the Engineer's design and drawings. Trim or remove any sharp objects that might puncture or tear the geotextile, refilling any voids created if necessary. If the pile caps are found to have sharp edges, it is recommended that the pile caps be covered over with a layer of non-woven geotextile as protection layer.

5. Installation

Mirafi® high strength reinforcement geotextiles are supplied generally in standard rolls of specific roll length and width. Before unrolling the geotextile, verify the roll identification, length, and installation location with the contract drawings. While unrolling the geotextile, inspect it for damage or defects. Discard or repair any damage that occurred during storage, handling or installation as directed by the Engineer.

Mirafi® High Strength Reinforcement Geotextiles for Piled Embankment Applications

5.1 For piled embankment requiring Mirafi® high strength reinforcement geotextile in one direction

When the piles are capped over with pile capping beams across the embankment, reinforcement is required in one direction only i.e. longitudinal direction of the embankment. Place the Mirafi® high strength reinforcement geotextile in the longitudinal direction of the embankment over prepared ground to be as smooth and wrinkle free as possible. Engineered backfilling shall be carried out using bulldozer to spread engineered fill evenly on the Mirafi® high strength reinforcement geotextile as per design drawings and/or the Engineer's instruction (see Figure 4). The primary machine direction of Mirafi® high strength reinforcement geotextile shall be laid perpendicular to the pile capping beam (see Figure 5).

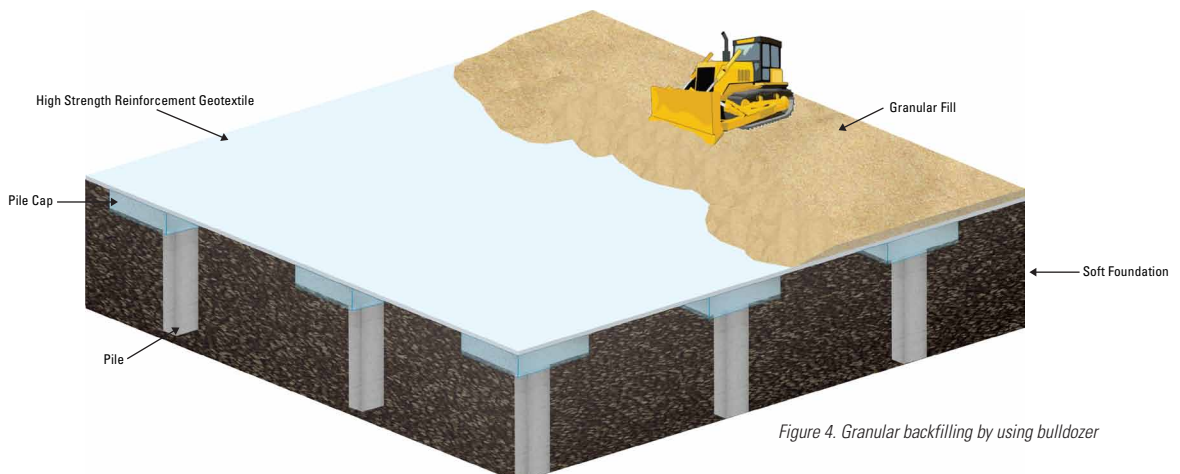

Figure 4. Granular backfilling by using bulldozer

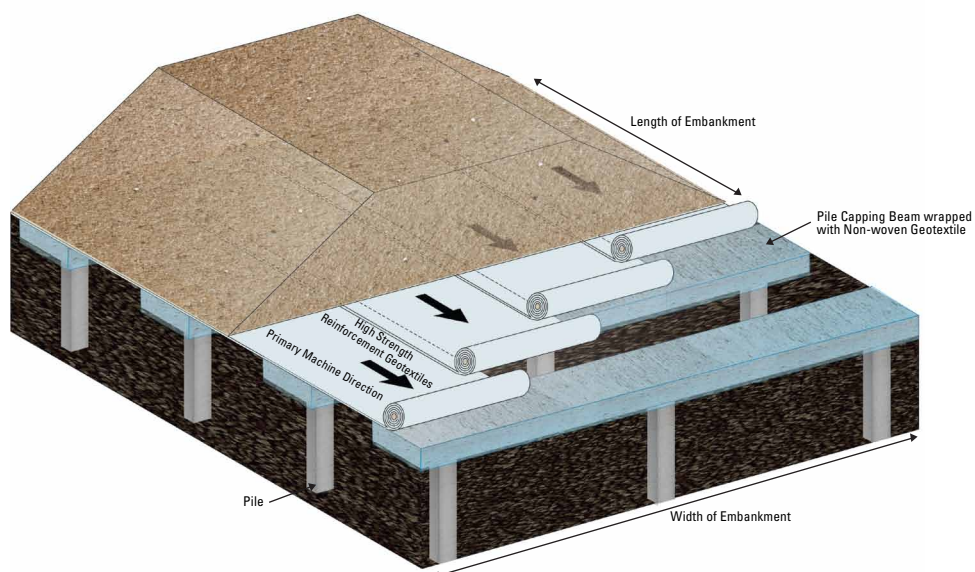

Figure 5. Laying of Mirafi® high strength reinforcement geotextile perpendicular to the pile capping beams

Mirafi® High Strength Reinforcement Geotextiles for Piled Embankment Applications

5.2 For piled embankment requiring Mirafi® high strength reinforcement geotextiles in two directions

When the piles are capped over with individual pile caps, the Mirafi® high strength reinforcement geotextiles are laid in two different directions typically perpendicular to each other.

Place the Mirafi® high strength reinforcement geotextile over prepared ground to be as smooth and wrinkle free as possible. Engineered backfilling shall be carried out using bulldozer to spread engineered fill evenly on the Mirafi® high strength reinforcement geotextile as per design drawings and/or the Engineer's instruction. The primary machine direction of the first layer of Mirafi® high strength reinforcement geotextile may be laid perpendicular to the alignment of embankment. Next, the second layer of Mirafi® high strength reinforcement geotextile shall be laid along the alignment of embankment. Hence, the first and second layers of Mirafi® high strength reinforcement geotextiles are perpendicular to each other (see Figure 6). Alternatively, the first layer of Mirafi® high strength reinforcement geotextile may be laid along the alignment of the embankment, followed with the second layer of Mirafi® high strength reinforcement geotextile to be laid across the embankment. The two layers of Mirafi® high strength reinforcement geotextiles may be laid directly on top of each other.

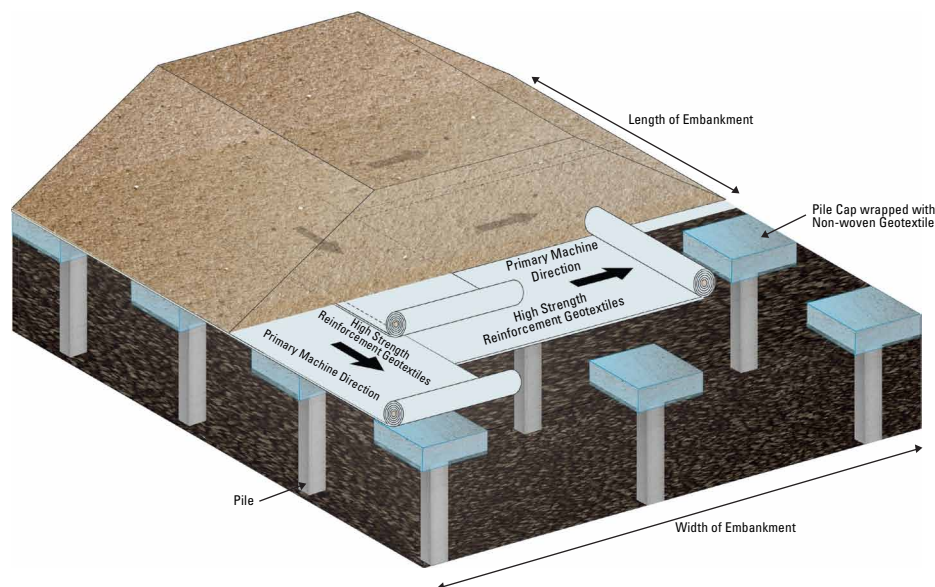

Figure 6. Laying of Mirafi® high strength reinforcement geotextiles over individual pile caps

Mirafi® High Strength Reinforcement Geotextiles for Piled Embankment Applications

6. Jointing

The Mirafi® high strength reinforcement geotextile shall be laid in a continuous layer in the primary machine direction for each of the required reinforcement laying direction. For very long embankment sections jointing in the primary machine direction may be unavoidable due to roll length limitations; under such circumstances jointing may be done with a minimum overlap spanning over 3 pile caps (see Figure 7). In the cross direction, the Mirafi® high strength reinforcement geotextile may either be overlapped or sewn together. A minimum geotextile edge overlap of 300 mm is generally sufficient to prevent formation of geotextile discontinuity during backfilling operation (see Figure 8).

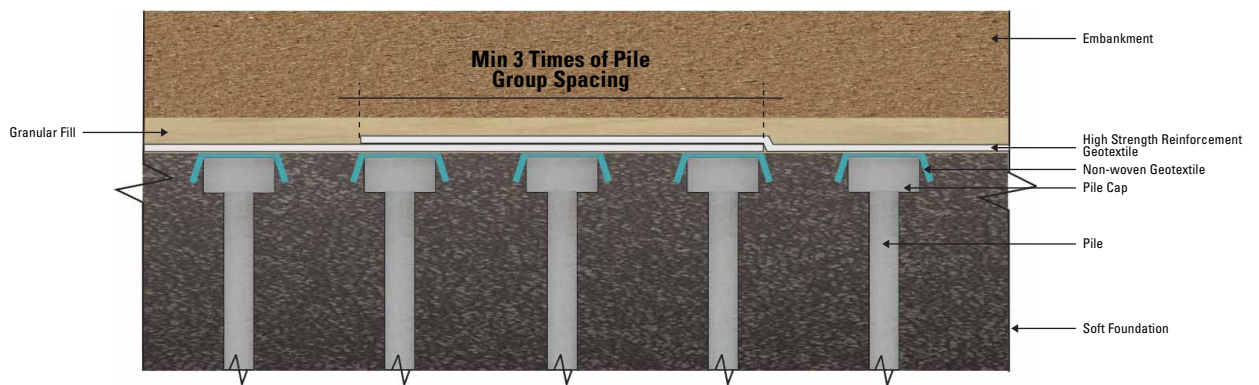

Figure 7. Typical overlap joint for Mirafi® high strength reinforcement geotextiles in the primary machine direction for very long embankment sections

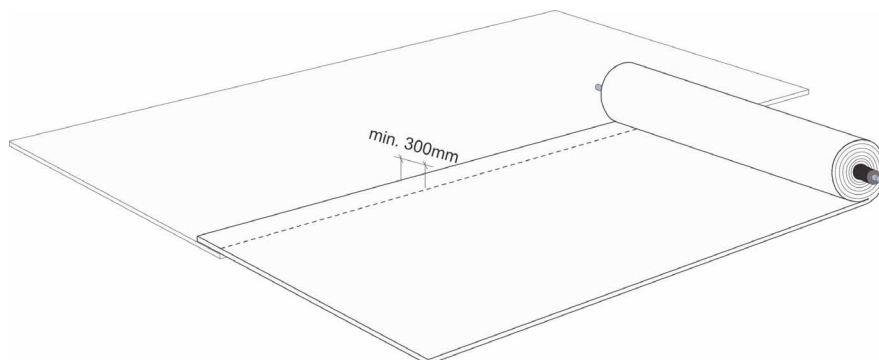

Figure 8. Typical overlap joint for Mirafi® high strength reinforcement geotextiles in the cross direction of the geotextile

Mirafi® High Strength Reinforcement Geotextiles for Piled Embankment Applications

7. Typical Anchorage Options

Proper anchorage or sufficient reinforcement bond length at the ends of the high strength reinforcement geotextile shall be provided according to the design drawings and/or the Engineer's instruction. There are two anchorage options recommended in the BS8006-1:2010 (see Figure 9a & 9b). These figures are adapted from "Code of practice for strengthened/reinforced soils and other fills"; BS8006-1:2010.

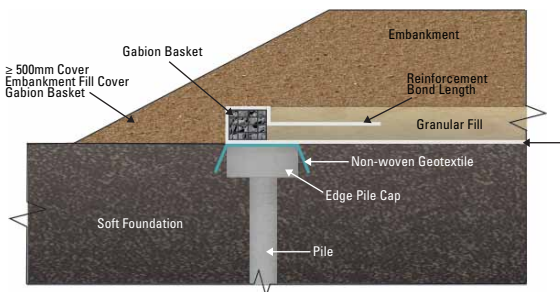

Figure 9a. Typical gabion anchor

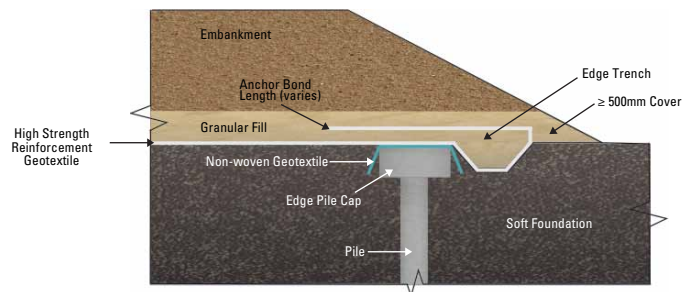

Figure 9b. Typical periphery trench

8. Backfilling and Compaction

Subsequently, embankment backfilling in approved lifts shall be carried out over the Mirafi® high strength reinforcement geotextile until the designed platform level. Unless otherwise instructed by the Engineer, embankment soil backfills are generally compacted to a minimum of 95% of the optimum dry density and +2% of the optimum moisture content, according to the AASTHO T-99.

TenCate Mirafi® is a registered trademark of Royal Ten Cate.

Further details of this application and products can be obtained by contacting your nearest TenCate Technical Support office. Unauthorized reproduction and distribution is prohibited. This document is provided as a supporting service only. The information contained in this document is to the best of our knowledge true and correct. No warranty whatsoever is expressed or implied or given. Engineers wishing to apply this information shall satisfy themselves on the validity of the input data relative to the applicable soil and engineering conditions and in doing so assume design liability.